

Washer extractor

WN6-11 Compass Pro



Washer featuring exceptional savings and effortless use



Priority on people

Certified ergonomic design with a human-centered approach for an outstanding user experience

Compass Pro® microprocessor offers:

- Easy program selection
- Language selection
- Quick selection and option buttons for the most frequently used wash programs and options
- Wash program packages optimized on Economy, Performance and Time



Long-term savings

Extremely low water and energy consumption – see table below

- High extraction force for efficient dewatering
- Super Balance guarantees the correct extraction force



Pure control

Monitoring of the status of the equipment and performance from anywhere, allowing to take action to improve the business

- Washers connectable to OnE Laundry, the personal assistant for hygiene validation, process management and revenue management



Global Advanced Hygiene

Global Advanced Hygiene program package* with proven log 6 reduction** disinfection of textiles through the laundry process, fulfilling the criteria of all local approved standards

Main options

- Automatic liquid detergent supply (optional I/O board)
- Connection to booking- /payment- system or coin meter



Images shown are a representation of the product only and variations may occur.

* Programs available in the standard library of all products, excluding products for specific segments where water temperature is not controllable.

** Log 6 reduction equals to 99,9999% viral infectivity reduction. The efficacy of reduction of SARS-CoV-2 and other pathogens in the process is confirmed by RISE (The Research Institute of Sweden) on the basis of Electrolux Professional laboratory data.

Main specifications				WN6-11			
Rated capacity, filling factor 1:9		kg/lb		11/25			
Drum, volume		litre		105			
		diameter	ø mm	595			
Extraction			rpm	625			
G-factor				130			
Standard heating alternatives	electricity	kW		7.5 / 10.0			
Low energy heating alternatives	electricity	kW		3.0			
	steam			x			
	non-heated			x			
Consumption data "Normal 60°C"				EI		Steam***	
Total time		min		Full load, 11 kg	Half load, 5.5 kg	Full load, 11 kg	Half load, 5.5 kg
Water consumption (cold+hot)		litre		45	43	45	43
Energy consumption (motor/heating/hot water)		kWh		61+19	49+13	80+0	62+0
Steam consumption		kg		0.15/0.55/1.2	0.1/0.4/0.8	0.15/-	0.1/-
Residual moisture		%		-	-	2.6	1.8
				65	74	65	74

* Water temperature 15°C cold water and 65°C hot water.

** Programs with AS.

*** Depending on steam pressure.

Electrical connections					
Heating alternative	Main voltage		Heating power kW	Total power kW	Recommended fuse A
		Hz			
Electric heated	220-240V 1/1N -	50/60	3.0/7.5/10.0	3.5/7.9/10.4	16/35/50
	220-240V 3 -	50/60	3.0/7.5/10.0	3.5/7.9/10.4	16/25/32
	380-415V 3/3N -	50/60	3.0/7.5/10.0	3.4/7.9/10.4	10/16/16
	440V 3 -	50/60	7.5/10.0	7.9/10.4	16
	480V 3 -	60	10.0	10.4	16
Steam or Non heated	208-240V 1/1N -	50/60	*	0.8	10
	380-480V 1 - (**)	50/60	*	0.8	10

* Total power and recommended fuse does not depend on the heating power in those cases.

** Prepared for 3 -.

Water and steam connection		WN6-11
Water valves	DN	20
Water pressure	kPa	200-600
Capacity at 300 kPa	l/min	20
Drain valve	ø mm	75
Draining capacity	l/min	170
Steam valve	DN	15
Steam pressure	kPa	300-600
Liquid detergent supplies		5
Floor requirements		
Frequency of the dynamic force	Hz	9.1
Floor load at max extraction	kN	1.9 ± 3.2
Sound levels		
Sound power/pressure level at extraction*	dB(A)	68/53
Sound power/pressure level at wash*	dB(A)	62/47
Heat emission		
% of installed power, max		5
Shipping data**		
Weight	net, kg	152
Shipping volume	m ³	0.88
Accessories		
Steel base		x
Hose kits for water or steam		x
Fluff collector		x
Dimensions in mm		
A Width		720
B Depth		700
C Height		1220
D1		370
D2		440
E		1185
F		920
G		80
H		1120
I		215
J		125
K		1100
L		1000
M		280
N		105
O		210
1 Operating panel	7 Drain valve	
2 Door opening ø 365 mm	8 Liquid detergent supply	
3 Detergent box	9 Electrical connection	
4 Cold water	10 Steam connection	
5 Hot water		
6 Re-used water		

Front and side panels in silver grey and dark blue (color samples can be ordered on part number 472998313).

* Sound power levels measured according to ISO 60704.

** Average data. Crated weight/shipping volume depends on configuration. Please contact logistics for exact measures.

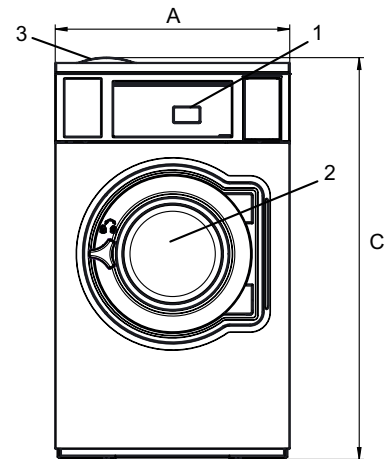

Front

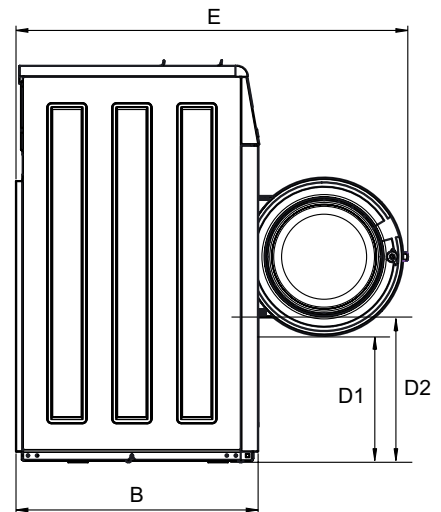

Side view

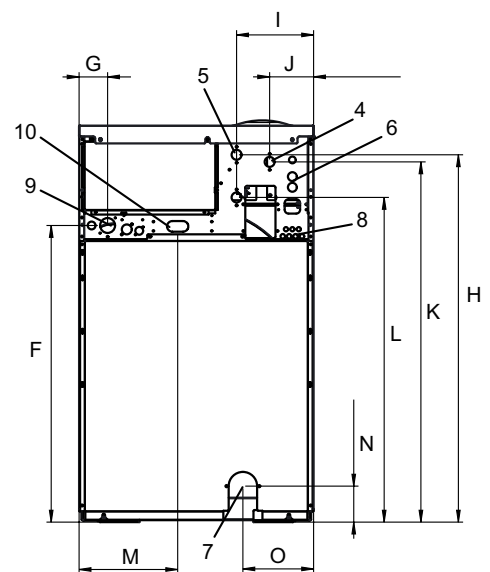

Rear